

## **ECO COMPOSITE FLOORING INSTALLATION MANUAL**

Thank you for choosing our flooring. When properly installed and cared for, your new flooring will be easy to maintain and will keep its great look for years. Please read all the instructions before you begin the installation. Improper installation will void the warranty.

### **I. GENERAL PREPARATIONS**

- Prior to installation, inspect the material in daylight for visible faults/damage, including defects or discrepancies in color or gloss; check the edges of the flooring for straightness and any damage. No claims on surface defects will be accepted after installation.
- For the best result, make sure to always work from 3 to 4 cartons at a time, mixing the planks during the installation.
- Check if subfloor/site conditions comply with the specifications described in these instructions. If you are not satisfied, do not install it, and contact your supplier.
- Flooring products can be damaged by rough handling before installation. Exercise care when handling and transporting these products. Store, transport and handle the cartons in a manner to prevent any damage. Store cartons flat, never on edge.
- Flooring products can be heavy and bulky. Always use proper lifting techniques when handling these products. Whenever possible, make use of material-handling equipment such as dollies or material carts. Never lift more than you can safely handle; get assistance.
- Calculate the room surface prior to installation and plan an extra 10% of flooring for cutting waste.
- The flooring is intended to be installed in interior locations only. It is not to be installed in areas that are exposed to the elements, such as outdoor areas, semi-covered / "alfresco" outdoor areas, porches, etc.
- Keep the boards in an unopened package at room temperature (between 15°C and 25°C) and a relative humidity of 35-65% for at least 24 hours before starting the installation.
- The room temperature must be maintained consistently between 15-25°C and relative humidity at 35-65% before and during the installation. Portable heaters are not recommended as they may not heat the room and subfloor sufficiently. Kerosene heaters should never be used.
- After installation the room temperature must be between 0°C and 50°C at 35-65% relative humidity.
- For surfaces below 400 m<sup>2</sup> and/or lengths below 20 m, use 10 mm expansion gaps.
- For surfaces between 400 m<sup>2</sup> and 600 m<sup>2</sup> and/or lengths between 20 m and 24 m, increase the expansion gaps to 15 mm.
- For surfaces above 600 m<sup>2</sup> and/or lengths above 24 m, use expansion moldings leaving min 15 mm.

### **II. SUBFLOOR INFORMATION**

- The flooring can be installed over most existing hard surface floor coverings, provided that the existing floor surface is structurally sound, clean, dry, and smooth. Subfloor variations should not exceed 5 mm in a 3 m radius.
- The substrate should not slope more than 25 mm per 2 m in any direction.
- The product can be installed on substrates with grout joints or grooves if these are less than 5 mm in width and 4 mm in depth. Depressions, deep grooves, expansion joints, and other subfloor imperfections that do not meet this requirement must be filled with patching & leveling compound prior to installation.
- Substrates must be free from excessive moisture or alkali. Remove dirt, paint, varnish, wax, oils, solvents, and any foreign matter and contaminants.

- Do not use products containing petroleum, solvents, or citrus oils to prepare substrates.
- Although this floor is waterproof, it is not to be used as a moisture barrier, excessive subfloor moisture can be a breeding ground for mold, mildew, and fungus – all of which can contribute to an unhealthy indoor environment.

## **WOOD SUBFLOORS**

- If this flooring is intended to be installed over an existing wood floor, it is recommended to repair any loose boards or squeaks before you begin the installation.
- Wood subfloors must have no more than 12% MC (moisture content).
- Nail or screw every 15 cm along joints to avoid squeaking.
- Basements and crawl spaces must be dry. Use of a 0.15 mm poly-film is required to cover 100% of the crawl space earth.
- Lay the flooring crossways to the existing floorboards.
- All other subfloors - plywood, OSB, particleboard, chipboard, wafer board, etc. must be structurally sound and must be installed following their manufacturer's recommendations.
- Double-layered APA-rated plywood subfloors should be a minimum of 25 mm total thickness, with at least 45 cm well-ventilated air space beneath.

## **CONCRETE SUBFLOORS**

- Existing concrete subfloors must be fully cured, at least 60 days old, smooth, permanently dry, clean, and free of all foreign material such as dust, wax, solvents, paint, grease, oils, and old adhesive residue.
- The subfloor must be dry. With a pH limit of 9 and comply with moisture content requirements and tested as per the below methods:
  - Concrete moisture vapor emissions must not exceed 3.63 kg MVER (moisture vapor emission rate) per 93 m<sup>2</sup> per 24 hours. This can be measured with the calcium chloride test (ASTM F1869).
  - 90% RH (ASTM F2170).
  - Max. 2.5% moisture content (CM method / ASTM F2659).
  - Max. 4.0 MC as per ASTM F2659 (a meter calibrated for concrete and qualified by gravimetric testing must be used).

**Note:** It may not be the floor covering installer's responsibility to conduct these tests. It is, however, the floor covering installer's responsibility to make sure these tests have been conducted, and that the results are acceptable prior to installing the floor covering. When moisture tests are conducted, it indicates the conditions only at the time of the test. The floor should not be installed on a subfloor with excessive moisture emission.

- It is required to use a minimum 0.15 mm poly-film as a moisture barrier between the concrete subfloor and the flooring.

## **DO NOT INSTALL OVER**

- Any type of carpet.
- Existing cushion-backed vinyl flooring.
- Any type of floating floor.
- Hardwood flooring/wood subfloors that lay directly on concrete or over dimensional lumber or plywood used over concrete.

## IMPORTANT NOTICE

In-floor Radiant Heat: Flooring can be installed over 12 mm embedded radiant heat using the floating method. Maximum operating temperature should never exceed 30°C. The use of an in-floor temperature sensor is recommended to avoid overheating.

- Turn the heat off for 24 hours before, during, and 24 hours after installation when installing over radiant heated subfloors.
- Before installing over newly constructed radiant heat systems, operate the system at maximum capacity to force any residual moisture from the cementitious topping of the radiant heat system.
- Floor temperature must not exceed 30°C.
- Once the installation has been completed, the heating system should be turned on and increased gradually (5°C increments) until returning to normal operating conditions.
- Refer to the radiant heat system's manufacturer recommendations for additional guidance.

**Warning:** Electric heating mats that are not embedded into the subfloor are not recommended for use underneath the floors. Using electric heating mats that are not embedded and applied directly underneath the floors could void the warranty for your floor in case of failure. It is best to install the flooring over embedded radiant floor heating systems and adhere to the guidelines listed above.

## III. INSTALLATION

**TOOLS AND SUPPLIES REQUIRED:** Spacers / Saw / Adhesive Tape / 0.15 mm or thicker Poly-film Vapor Barrier / Ruler / Pencil / Tape Measure / Construction Adhesive / Chalk Line / Tapping Block / Rubber Mallet.

**For straight cuts:** Electrical hand saw, circular saw, miter saw, or table saw with a carbide-tipped wood combination blade or a continuous or segmented diamond blade.

**For rounded cuts:** Bi-metal or tungsten carbide jigsaw.

**Important:** When cutting this product please use a dust mask or other safeguards for personal protection, it is advised to cut in a well-ventilated area.

- Remove baseboard, quarter-round moldings, wall base, appliances, and furniture from the room. For best results, the door trim should be under-cut to allow the flooring to move freely without being pinched. After preparation work, sweep and vacuum the entire work area to remove all dust and debris.
- Whenever possible, plan the layout so that the joints in the planks do not fall on top of joints or seams in the existing substrate. The end joints of the planks should be staggered a minimum of 20 cm apart. Do not install over expansion joints. Avoid installing pieces shorter than 30 cm at the beginning or end of rows.
- Do not install your kitchen cabinets directly over your floor. Built-in cabinets, kitchen cabinets, islands, and similar heavy items must be installed first. Only then can the flooring be installed, leaving a 10 mm expansion gap around it.
- With a floating floor, you must always ensure a 10 mm gap between the flooring and walls or fixtures such as pillars, stairs, etc. This gap will be covered with trim moldings after the floor is installed. The quality of the floor can only be guaranteed if it is allowed to move freely. It must not be nailed, adhered, or fastened to the subfloor in any way.
- **NOTE:** DO NOT FILL IN THE EXPANSION GAPS WITH SILICONE. FOR INSTALLATION IN BATHROOMS, LAUNDRY ROOMS, OR COMMERCIAL INSTALLATIONS, SEE THE CORRESPONDING SECTION BELOW.

- ADDITIONAL UNDERLAY:** An additional underlayment is optional; however, it should meet the following requirements: 1 mm maximum thickness with a high density ( $>135 \text{ kg/m}^3$ ) and high compressive strength ( $\geq 200 \text{ kPa}$  according to EN 16354, ASTM D3575-20, Suffix D and  $<10\%$  according to ASTM D3575-20, Suffix B). Thicker underlayments, underlayments with a low density and inadequate compressive strength could damage the locking mechanism and will void the warranty.  
 If the floor HAS a pre-attached underlayment, the use of an additional underlayment could damage the locking mechanism and will VOID warranty.

**ATTENTION:** The letter 'L' or 'R' marked on the back of each herringbone plank indicates two different profiling directions. There is the same number of L planks and R planks in each box. Please pay attention to the markings and always install them paired together. In the below instructions, L planks are represented in white, R marked planks are represented in grey.

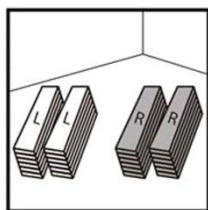

- Separating into distinctive piles will make it easier to find the correct plank should the L or R markings be cut off.

### METHOD 1 – FISHBONE DIAGONAL PATTERN

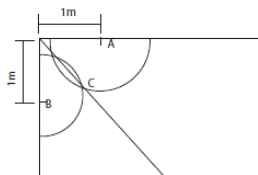
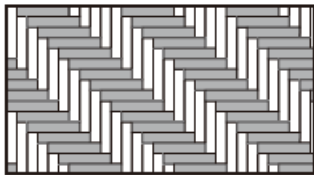

- Using a pencil, a string and a ruler, draw a line at  $45^\circ$  that will be used to align the pattern according to the image. You can then start staggering your spacers across your wall, leaving a 10 mm expansion gap with the wall.

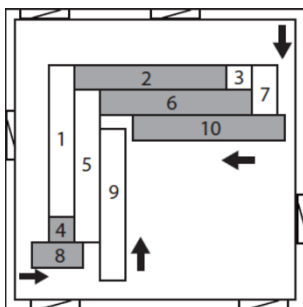

- Start from the left corner opposite the door. Use an 'L' marked plank first and put the tongue sides against the wall. Then take your 2nd plank (marked 'R') and place it perpendicularly to the 1st (refer to the clicking tips on the bottom of the page). For the 3rd and 4th plank, refer to the cutting tips below. Continue the installation according to the sequence.

**CUTTING TIPS:** To install the 3rd (L), 4th (R), and any other plank that will have the short side against the wall, measure the length of the plank to fit and cut accordingly. Make sure you use the correct side of the plank (see images below).

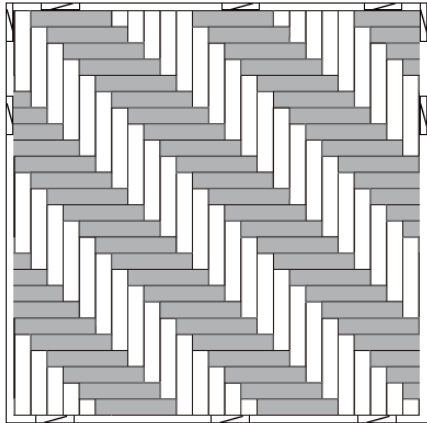
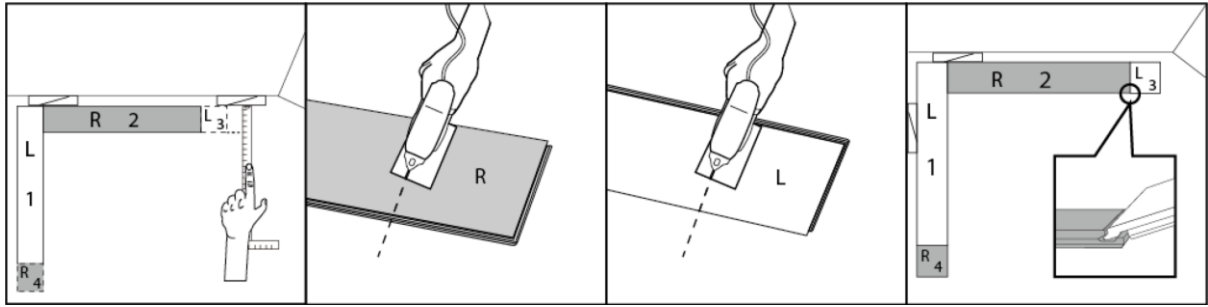

This sequence is given as an example; it will depend on the shape of the room. It is important is to always start with the planks placed against the walls.

## METHOD 2 – FISHBONE PATTERN

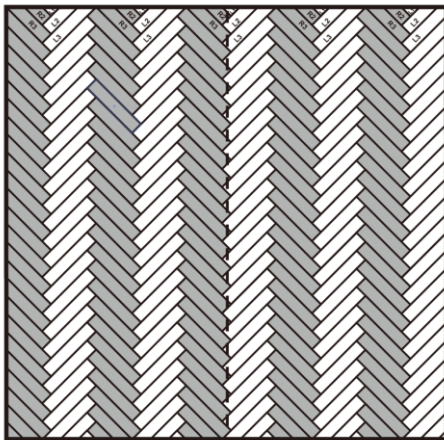

One starting set

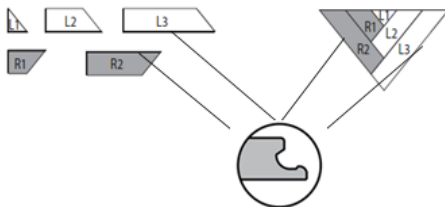

- First, follow the cutting template on the inside of your box to cut the 5 pieces (L1, L2, L3, R1, R2) needed for one starting set. You will need a total of 5 planks to make the required 5 starting set pieces (L1, L2, L3, R1, R2). You won't be able to use offcuts of the same planks within one set.

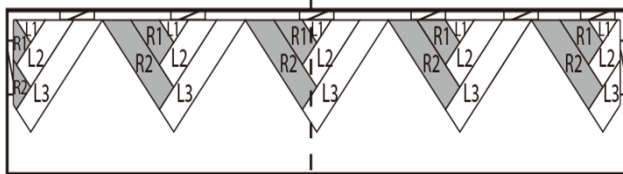

- Align the first starting set with a chalk line going through the center line of the room (to center the installation, make sure the line goes through the middle of the short side of the planks). Always leave a 10 mm expansion gap with the wall.

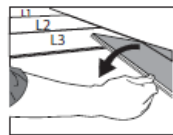
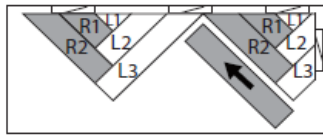

- You can connect the starting sets with one full plank.

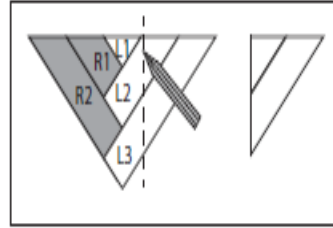
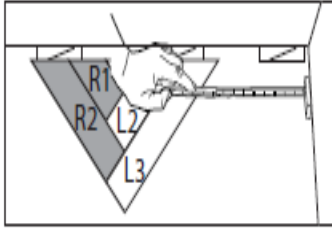

- When you reach the walls on both sides, measure the distance between the wall and the closest starting set. Assemble a new set, mark the measured distance on it, cut the planks (the set can be disassembled for this) and install the planks in the gap.

- Continue this pattern until the room is entirely covered.

### METHOD 3 – DOUBLE FISHBONE PATTERN

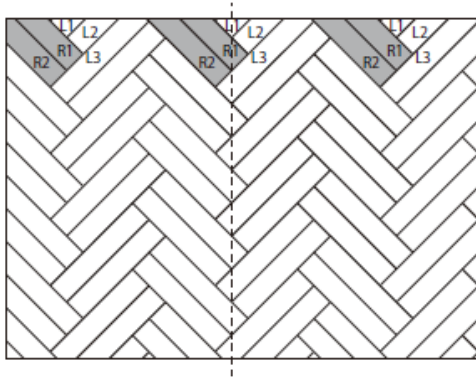

**IMPORTANT:** We recommend to scrape off the sealer on the edges with a sanding paper on the locking system, then apply a hard-setting waterproof wood adhesive inside the locking system at the short side of the planks for additional engagement, avoid using adhesive excessively and be sure to immediately wipe away any excess that comes out to the floor's surface.

**ATTENTION!** For the double fishbone pattern, the cuts are different than what is indicated in the template inside of the box. Use measurements in the Addendum to cut the 5 planks (L1, L2, L3, R1, R2) of the starting set to the right size.



One starting set

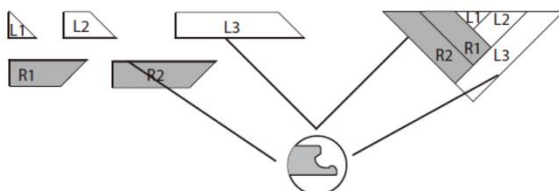

- You will need a total of 5 planks in order to make the required 5 starting set pieces (L1, L2, L3, R1, R2). You won't be able to use offcuts of the same planks within one set.

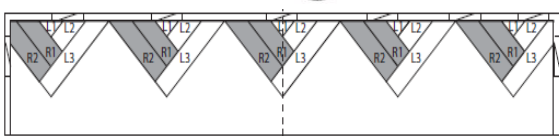

- Align the first starting set with a chalk line going through the center line of the room (to center the installation, make sure the line goes through the tip of the pattern). Always leave a 10 mm expansion gap with the wall.

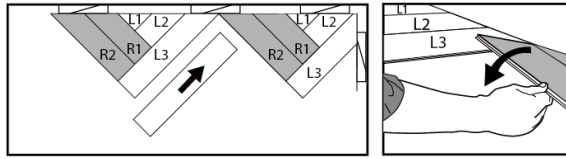

- You can connect the starting sets with one full plank.

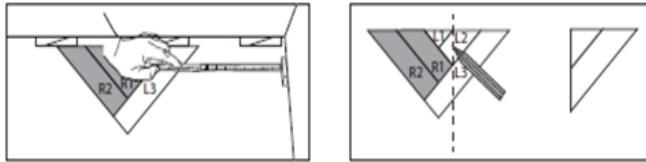

- When you reach the walls on both sides, measure the distance between the wall and the closest starting set. Assemble a new set, mark the measured distance on it, cut the planks (the set can be disassembled for this) and install the planks in the gap.

- Continue this pattern until the room is entirely covered.

### CLICKING TIPS

Place the short end tight to perpendicular plank. Click it into the long end of the parallel panel at a 45° angle. Fold down in a single movement. It is recommended to slightly tap the planks on the edge after clicking them together to make sure they are clicked tightly and aligned perfectly.

**IMPORTANT:** If you notice both planks aren't at the same height or are not well-locked together, please follow the disassembling instructions at the bottom of the page, disassemble, and check if any debris stuck inside the lock is obstructing. Failure to properly line up the end joint and attempting to force it in while out of alignment could result in permanent damage to the end joint.

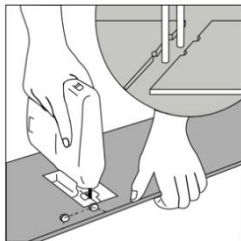

- **Holes for pipes:** Measure the diameter of the pipe and drill a hole that is 20 mm larger. Saw off a piece as shown in the figure and lay the board in place on the floor. Then lay the sawed-off piece in place.



- **Door molding and skirting:** Lay a board (with the decorative side down) next to the door molding and saw as shown in the figure. Then slide the floorboard under the molding.

### For Bathroom, Laundry Room, or Commercial Installations

It is important to seal any cut planks to ensure superior and warranted performance. When a flooring plank is cut to fit (either end cuts or side cuts), a sealant is always required around the perimeter of the installation.

Fill the expansion spaces with a 10 mm compressible PE foam backer rod and cover with a flexible 100% silicone sealant to the entire perimeter of the installation. Do not use an acrylic sealant.

Prior to installing moldings, apply silicone sealant to the portion of the molding or transition that will contact directly with the flooring surface.

Install moldings and immediately wipe away any excess silicone sealant.

Apply silicone sealant at connections to doorframes or any other fixed objects.

Branded and generic silicone tubes are available in any local home center or hardware location.

#### **IV. FINISHING THE INSTALLATION**

Replace molding or a wall base. Nail the molding to the wall surface, not through the flooring. In areas where the flooring planks may meet other flooring surfaces, the use of a transition molding is required to cover the exposed edge but do not pinch the planks. Leave a 10 mm gap between the planks and the adjoining surface.

#### **V. MAINTENANCE**

- Sweep or vacuum daily using soft bristle attachments.
- Clean up spills and excessive liquids immediately.
- Damp mop as needed, and use cleaners recommended and approved for this type of flooring.
- The use of residential steam mops on this product is allowed. Use at the lowest power with a suitable soft pad, and do not hold a steam mop on one spot for an extended period of time (longer than 30 seconds). Refer to the steam mop's manufacturer instructions for proper usage.
- Use proper floor protection devices such as felt protectors under furniture.
- Place a walk-off mat at outside entrances to reduce the amount of dirt brought into your home. Do not use mats with latex or rubber backing since these backings can cause permanent discoloration.
- Do not use abrasive cleaners, bleach, or wax to maintain the floor.
- Do not drag or slide heavy objects across the floor.
- When possible, use appropriate window coverings, such as drapes, window treatments, or UV-tinting on windows, to protect the product from prolonged exposure to intense heat.

#### **VI. DISASSEMBLY**

To disassemble, simply lift the planks one by one following the opposite sequence as the installation.